

APPROVAL - CUSTOMER NAME & SIGNATURE

DATE

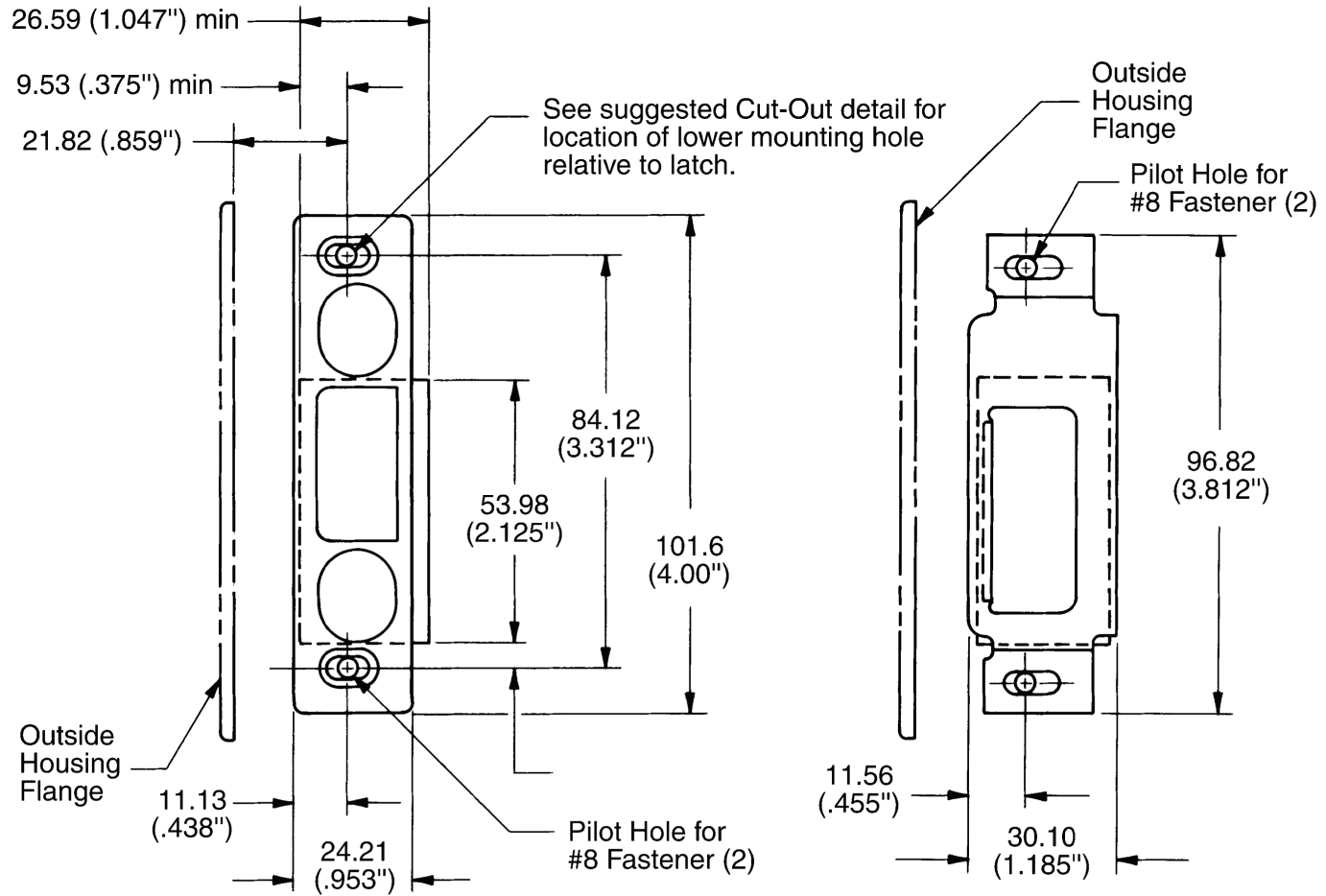

**ALLEGIS**

1-866-378-7550

MATERIAL:

DRAWING NO.:

11705-15

FINISH:

REV.:

1:1

DATE:

6/10/2019