

APPROVAL - CUSTOMER NAME & SIGNATURE

DATE

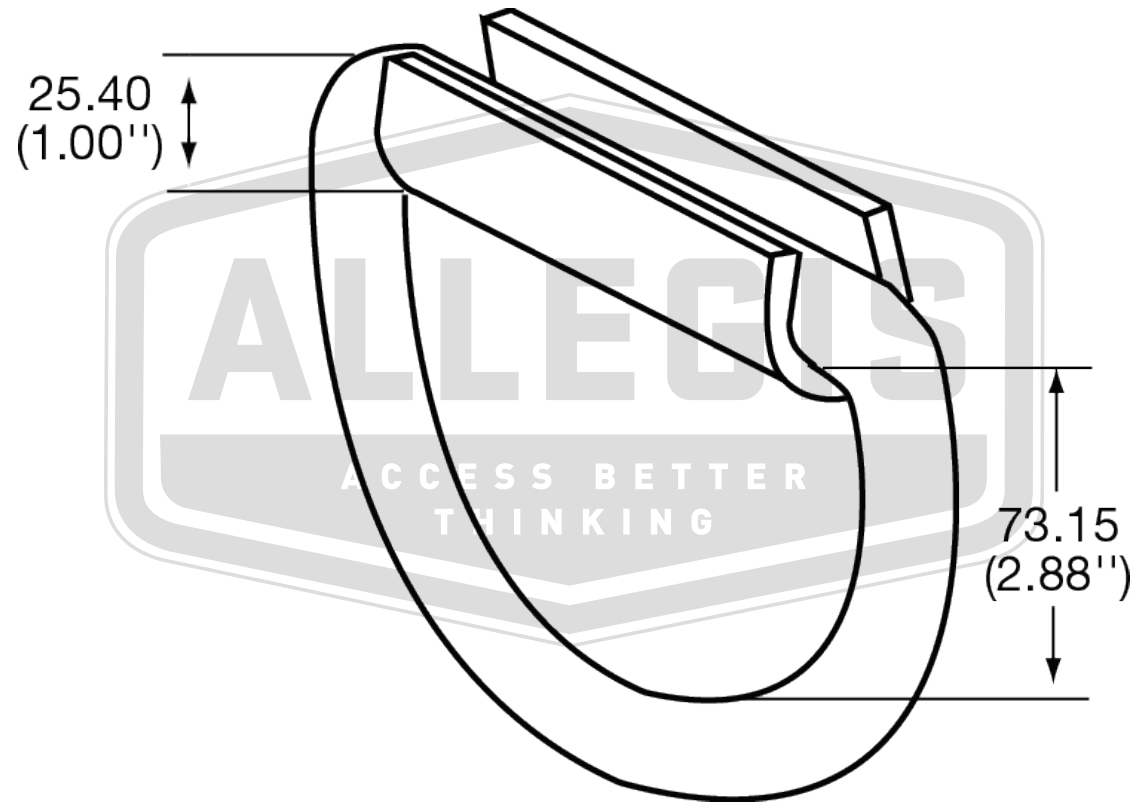

**ALLEGIS**

1-866-378-7550

MATERIAL:

DRAWING NO. :

982-0046

FINISH:

REV.:

1:1

DATE:

6/13/2019