

APPROVAL - CUSTOMER NAME & SIGNATURE

DATE

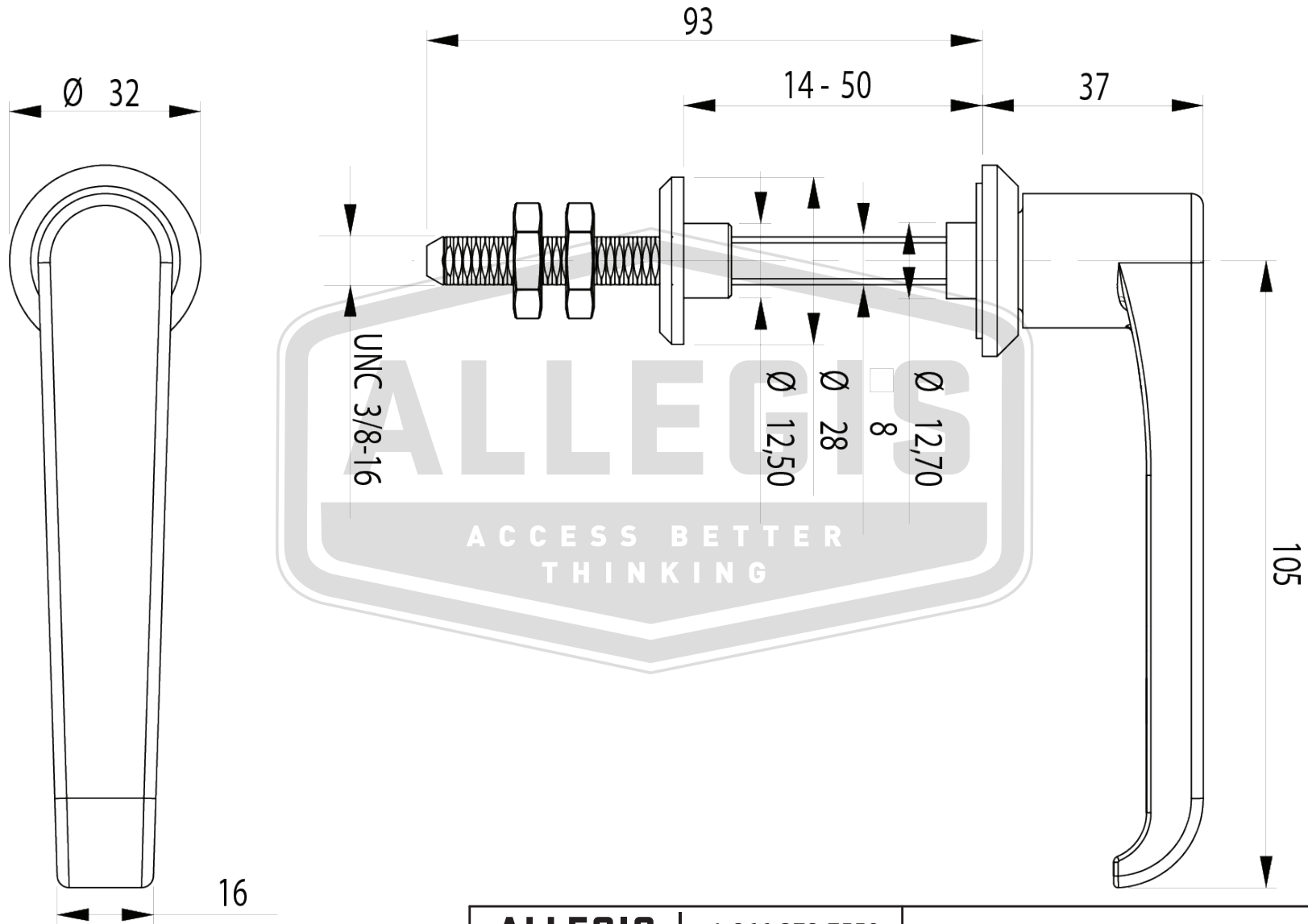

ALLEGIS		1-866-378-7550
MATERIAL:	DRAWING NO. : 265080	
FINISH:		
REV. : 1:1	DATE: 6/11/2019	