

APPROVAL - CUSTOMER NAME & SIGNATURE

DATE

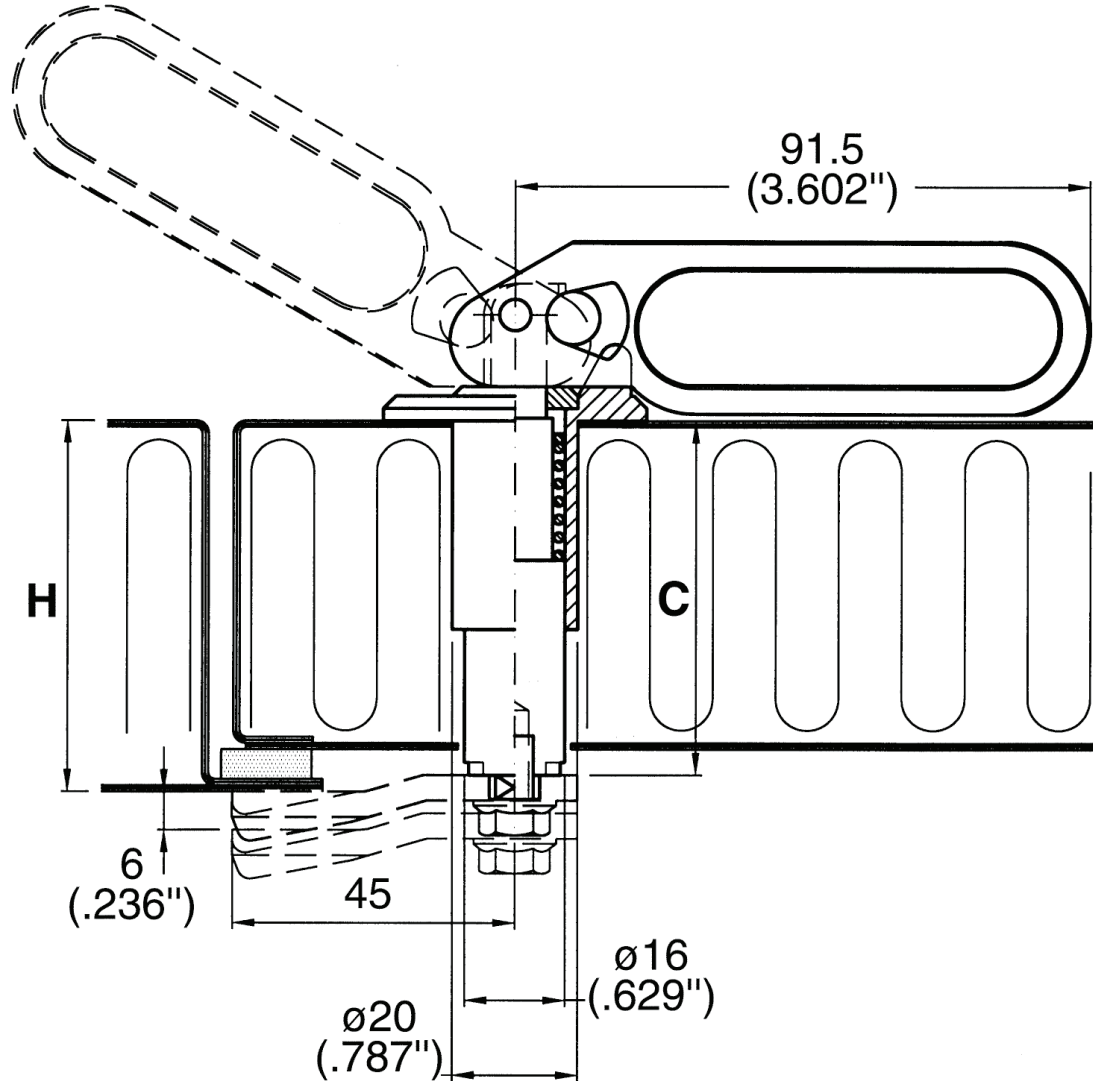

ALLEGIS

1-866-378-7550

MATERIAL:

DRAWING NO. :

275004-30

FINISH:

REV.:

1:1

DATE:

6/11/2019