

APPROVAL - CUSTOMER NAME & SIGNATURE

DATE

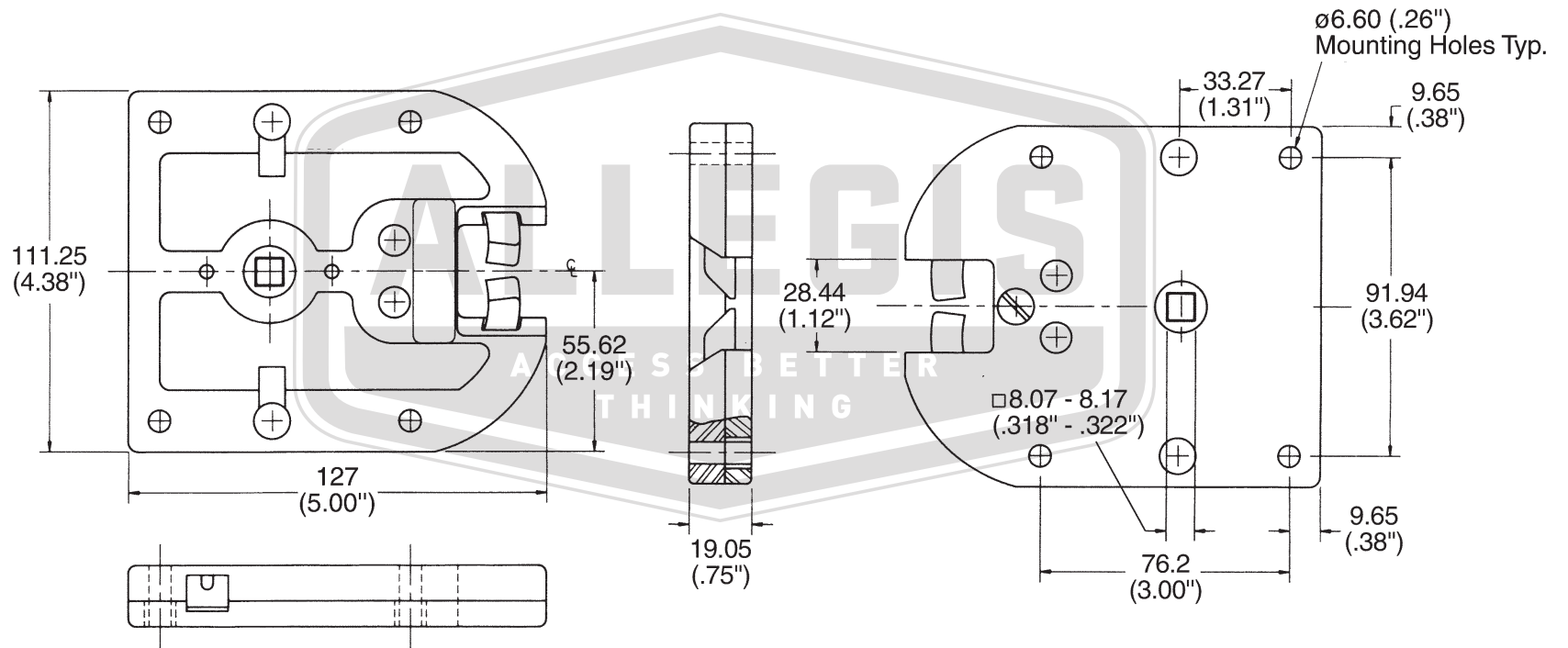

ALLEGIS		1-866-378-7550
MATERIAL:	Zinc	DRAWING NO. : 3-106 ZN
FINISH:		
REV.:	1:1	DATE: 6/11/2019