

APPROVAL - CUSTOMER NAME & SIGNATURE

DATE

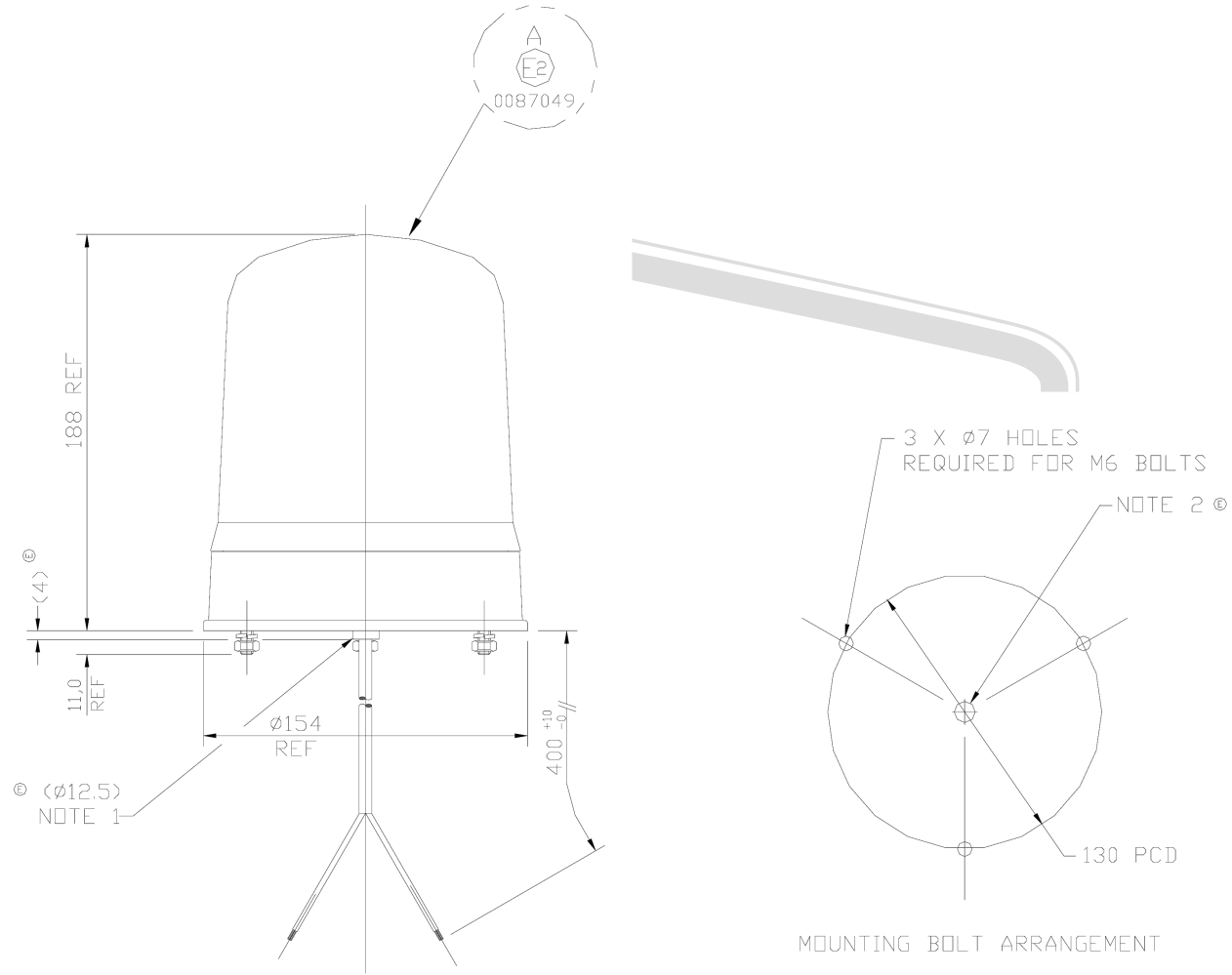

ALLEGIS		1-866-378-7550
MATERIAL:	DRAWING NO. : 370.00.12V	
FINISH: Amber		
REV. : 1:1	DATE:	6/12/2019