

APPROVAL - CUSTOMER NAME & SIGNATURE

DATE

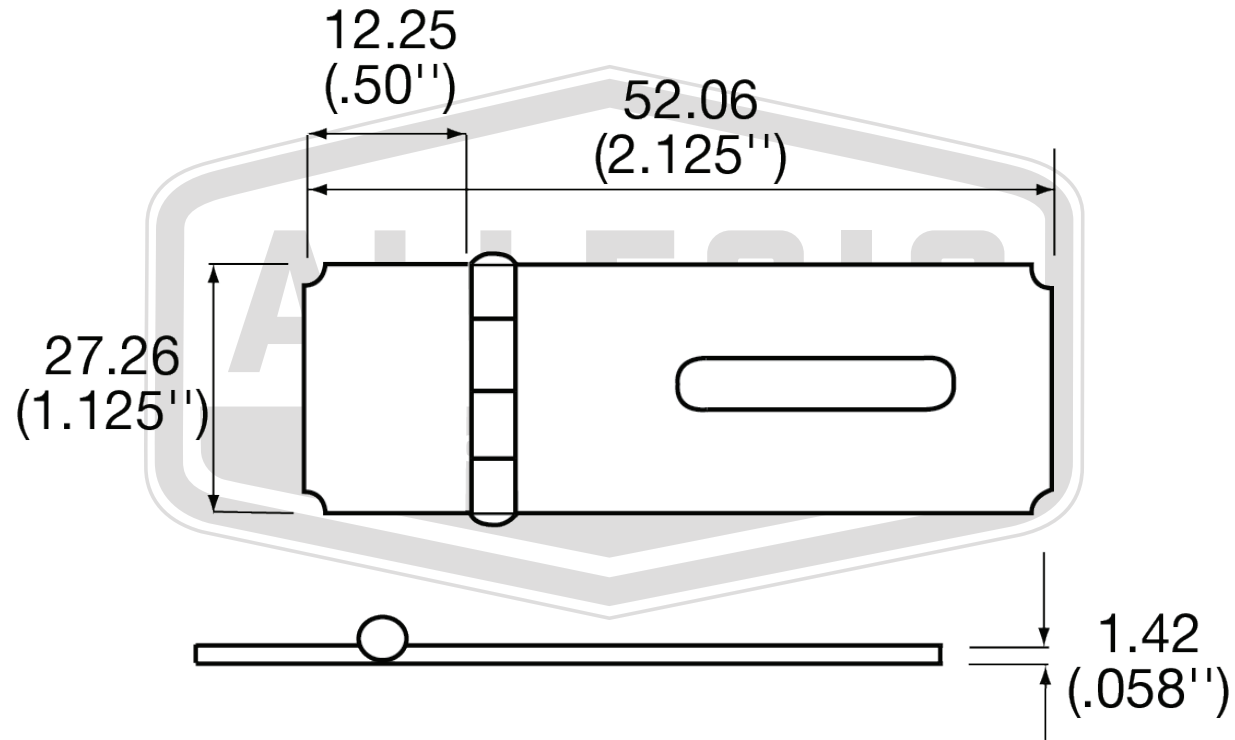

ALLEGIS

1-866-378-7550

MATERIAL:

Plain Steel

DRAWING NO. :

4-825

FINISH:

REV.:

1:1

DATE:

6/12/2019