

APPROVAL - CUSTOMER NAME & SIGNATURE

DATE

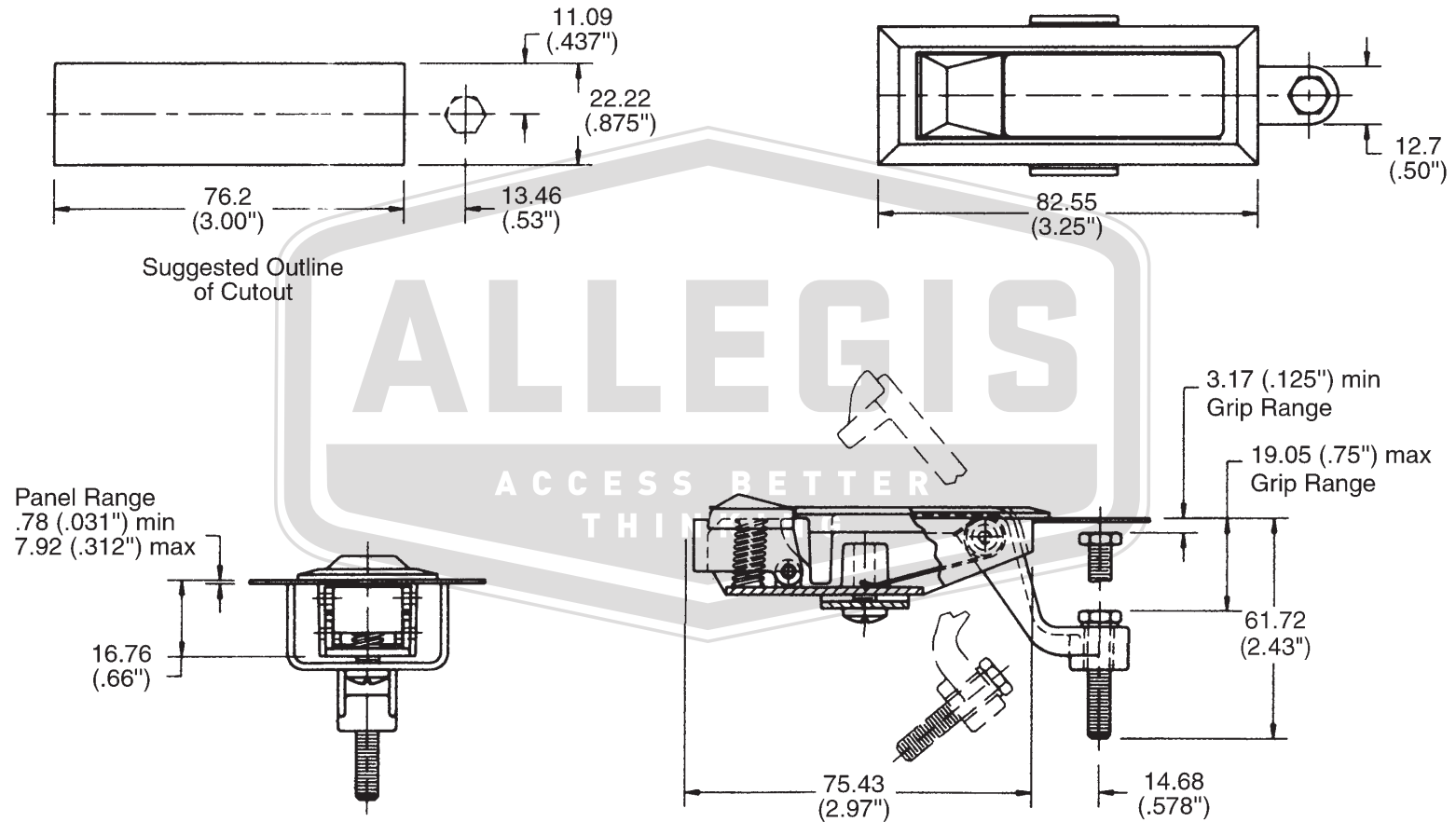

ALLEGIS		1-866-378-7550
MATERIAL:	DRAWING NO. :	
	534	
FINISH:	Black	
REV.:	1:1	DATE: 6/12/2019