

APPROVAL - CUSTOMER NAME & SIGNATURE

DATE

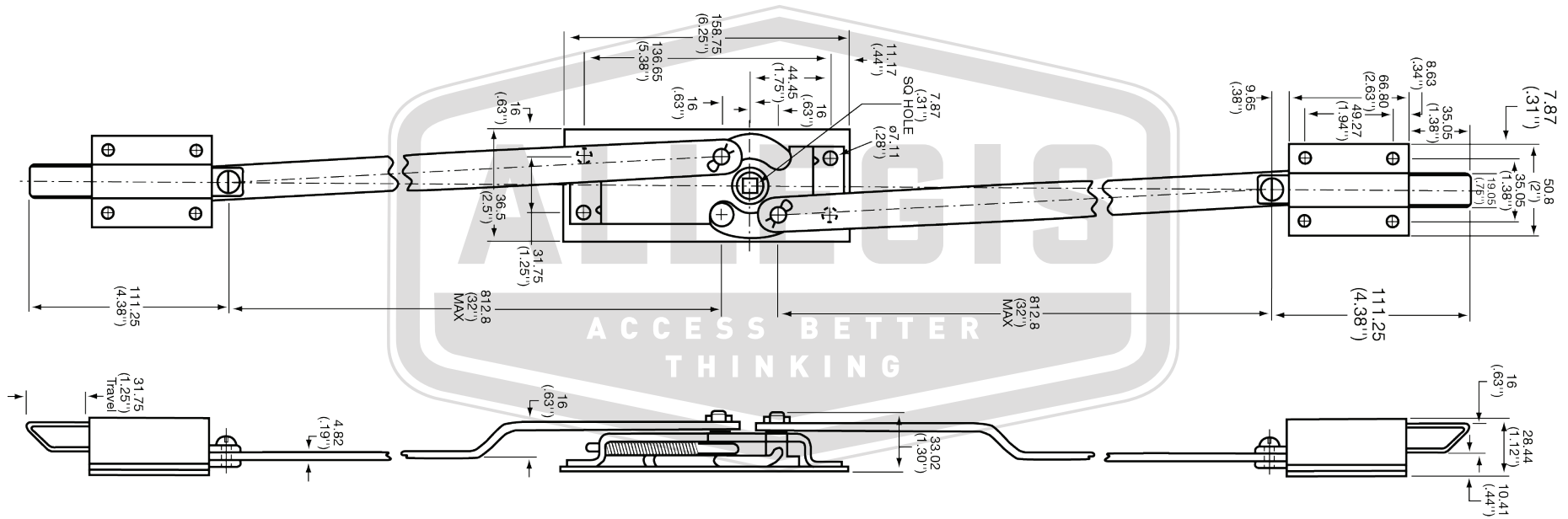

ALLEGIS	1-866-378-7550
MATERIAL: Zinc	DRAWING NO. : 5658 ZN
FINISH:	
REV.: 1:1	DATE: 6/12/2019