

APPROVAL - CUSTOMER NAME & SIGNATURE

DATE

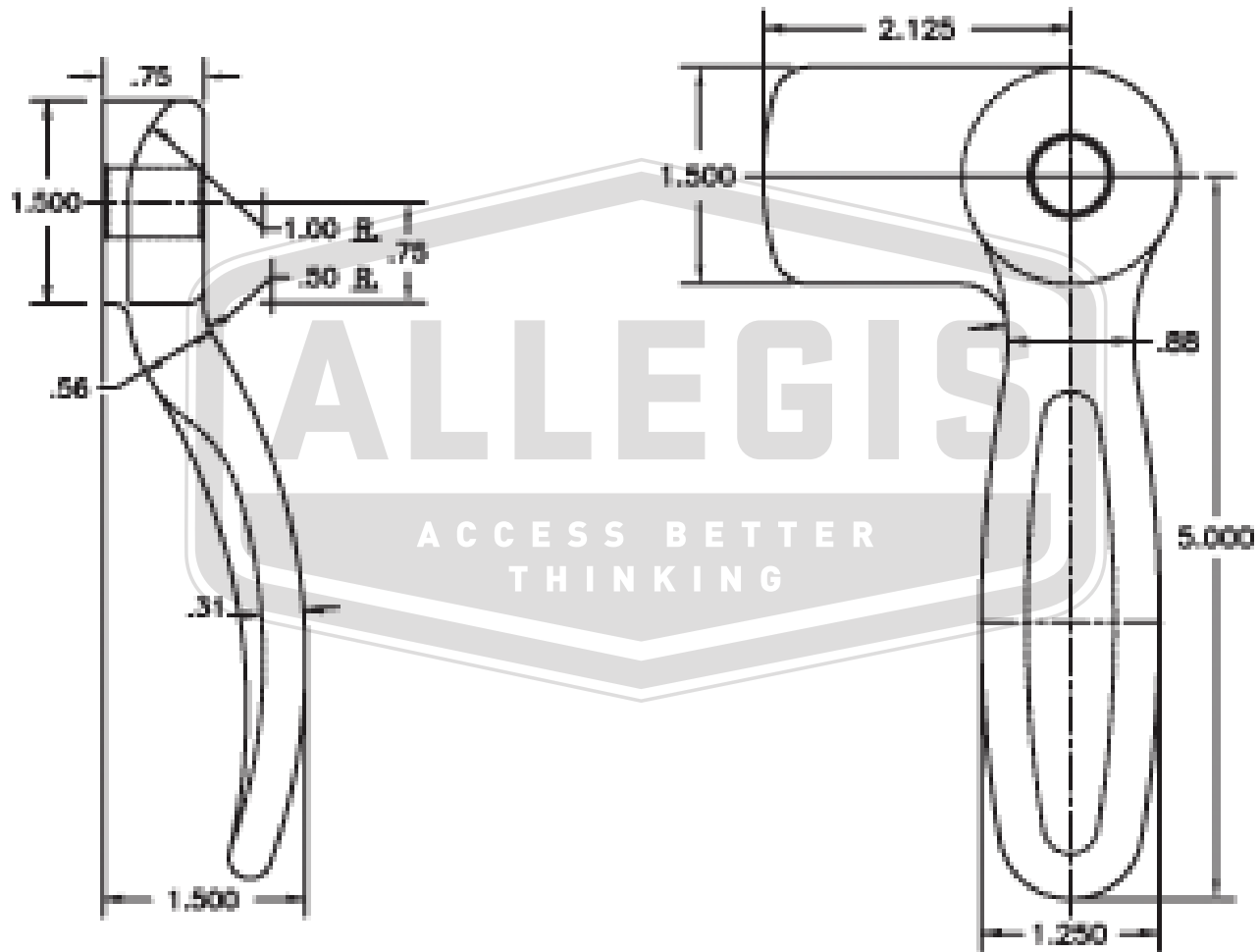

ALLEGIS

1-866-378-7550

MATERIAL:

Zinc

DRAWING NO.:

5809 ZN

FINISH:

REV.:

1:1

DATE:

6/12/2019