

APPROVAL - CUSTOMER NAME & SIGNATURE

DATE

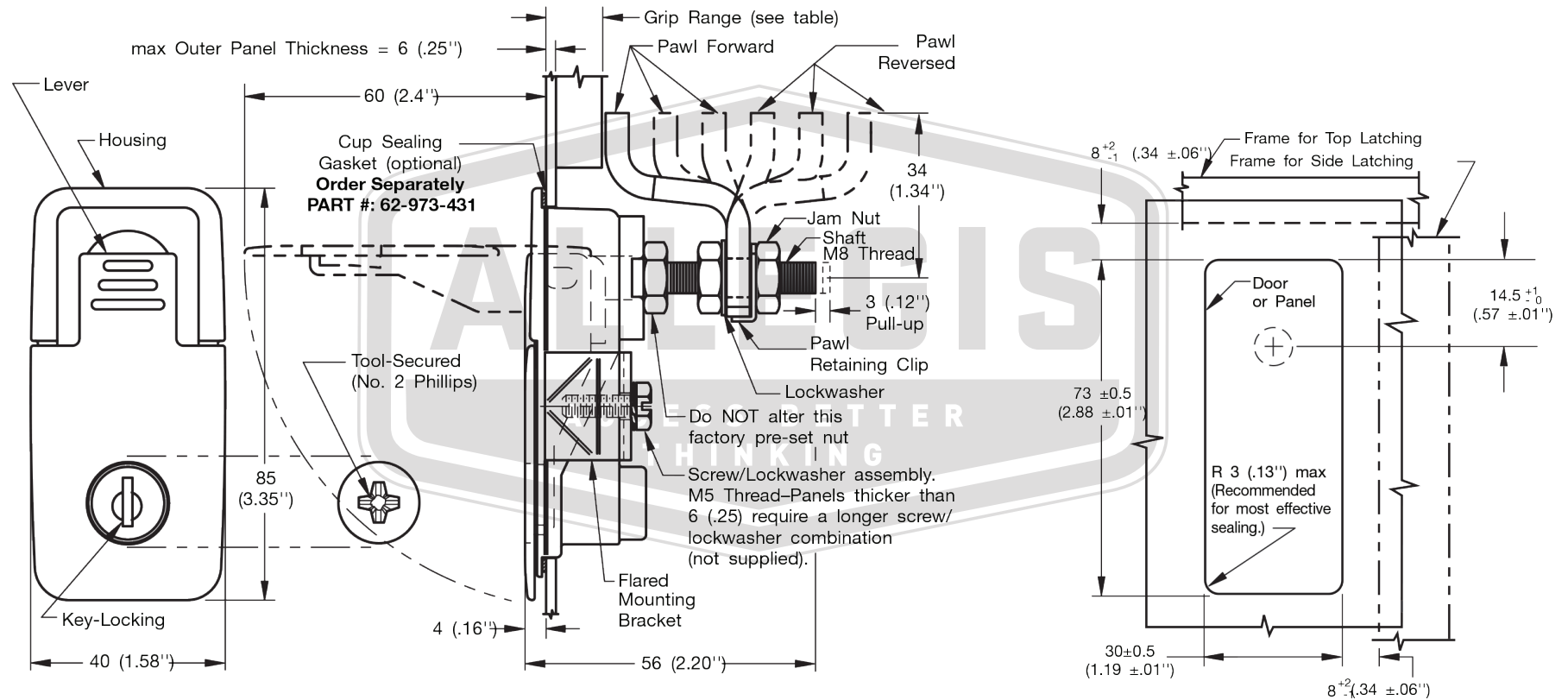

ALLEGIS

1-866-378-7550

MATERIAL:

DRAWING NO. :

62-40-251

FINISH:

REV.:

1:1

DATE:

5/30/2019