

APPROVAL - CUSTOMER NAME & SIGNATURE

DATE

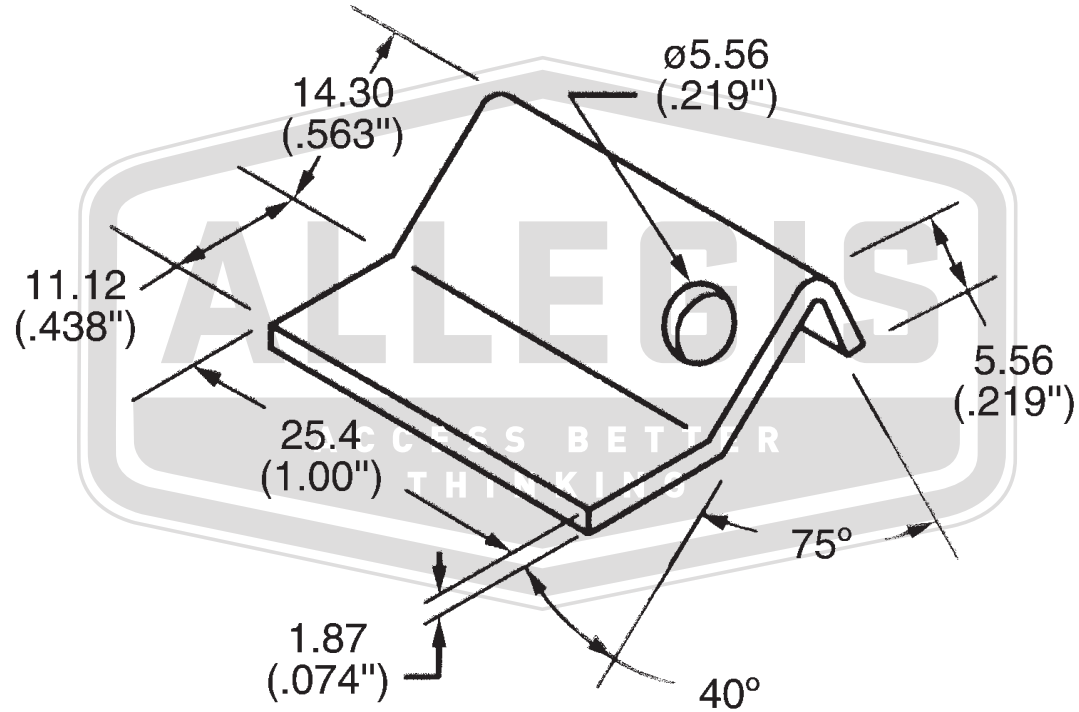

ALLEGIS		1-866-378-7550
MATERIAL:	Stainless Steel	DRAWING NO. : AC 12-8 SS
FINISH:		
REV.:	1:1	DATE: 6/13/2019