

REV	DATE	DRAWN/CHKD	DESCRIPTION	ITEM	PART NUMBER	MATERIAL	FINISH	PULL-UP FORCE
B	31OCT98	JGK/	PRN: C3-143	ASSEMBLY	C3-803	-	-	13N (3 LBS)
C	03MAR2000	KPL/	PRN: PC3-154	ASSEMBLY	C3-805	-	-	22N (5 LBS)
D	24MAR2004	AAB/RLR	PRN: P2004-0308	ASSEMBLY	C3-810	-	-	44N (10 LBS)
E	14DEC2005	RLR/MJS	PRN: P2005-1775	RIVET	-	ALUMINUM	NATURAL	-
F	16OCT2009	ACH/MJS	PRN: P2009-1204	HOUSING	-	PC/ABS, SEE NOTE F	BLACK	-
G	18OCT2016	CMS/GC	PRN: P2016-2391	SPRING	-	302 STAINLESS STEEL	SEE NOTE E	-
H	19JAN2017	CMS/CLB	PRN: P2016-2637	KEEPER	-	MINERAL FILLED NYLON	BLACK	-
I	06FEB2019	CMS/BS	PRN: P2019-0308	SPRING SUPPORT	-	GLASS FILLED NYLON	BLACK	-
				SUPPORT ROD	-	GLASS FILLED NYLON	BLACK	-
				PAWL	-	GLASS FILLED NYLON	BLACK	-

ASSEMBLY PART NUMBER	CATCH	KEEPER
C3-803	C3-12-03	C3-77
C3-805	C3-12-05	C3-77
C3-810	C3-12-10	C3-77

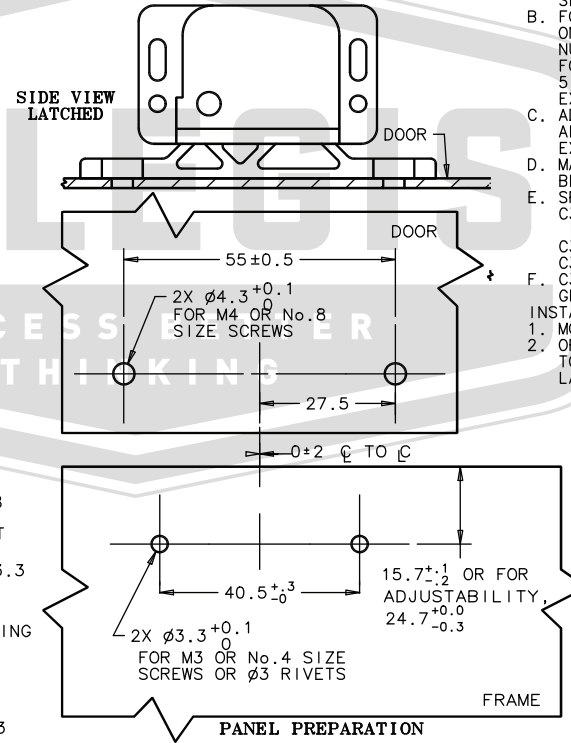
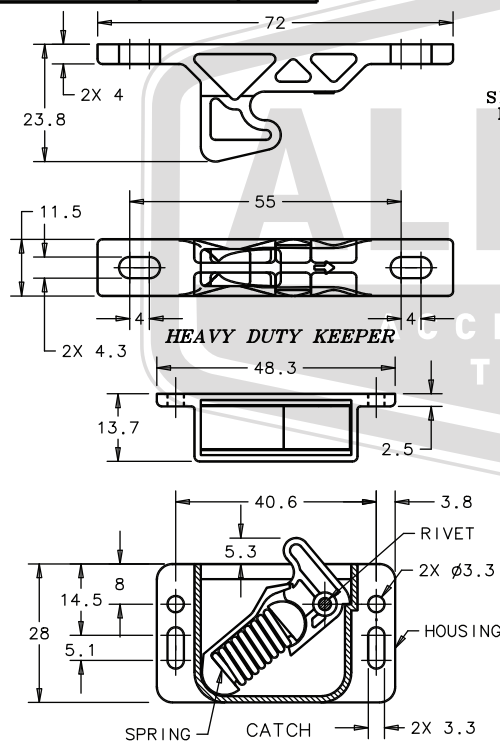

PACKAGING NOTES:

- CATCH AND KEEPER SHIPPED SEPARATELY, BULK.
- FOR CATCH AND KEEPER PACKAGED ONE PER BAG, ADD -P TO PART NUMBER. EXAMPLE: C3-803-P.
- FOR CATCH AND KEEPER PACKAGED 5 PER BAG, ADD -P5 TO PART NUMBER. EXAMPLE: C3-810-P5.
- ADD "A-W" FOR ASSEMBLIES WITH ALL WHITE COMPONENTS. EXAMPLE: C3-810-W.
- MATERIAL FOR WHITE KEEPER WILL BE GLASS REINFORCED NYLON.
- SPRING FINISH:
 - C3-803 = PASSIVATED, BLUE ORGANIC COATING
 - C3-805 = PASSIVATED
 - C3-810 = PASSIVATED, BLACK OXIDE
 - C3-810 BLACK HOUSING MADE WITH GF NYLON.

INSTALLATION INSTRUCTIONS:

- MOUNT CATCH TO FRAME.
- ORIENT KEEPER TO LATCH, MOUNT TO DOOR AND ADJUST FOR SMOOTH LATCHING.

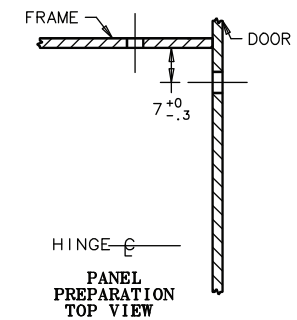

ALLEGIS		1-866-378-7550
MATERIAL:	Plastic	DRAWING NO. : C3-805
FINISH:		
REV.:	1:1	DATE: 5/29/2019