

APPROVAL - CUSTOMER NAME & SIGNATURE

DATE

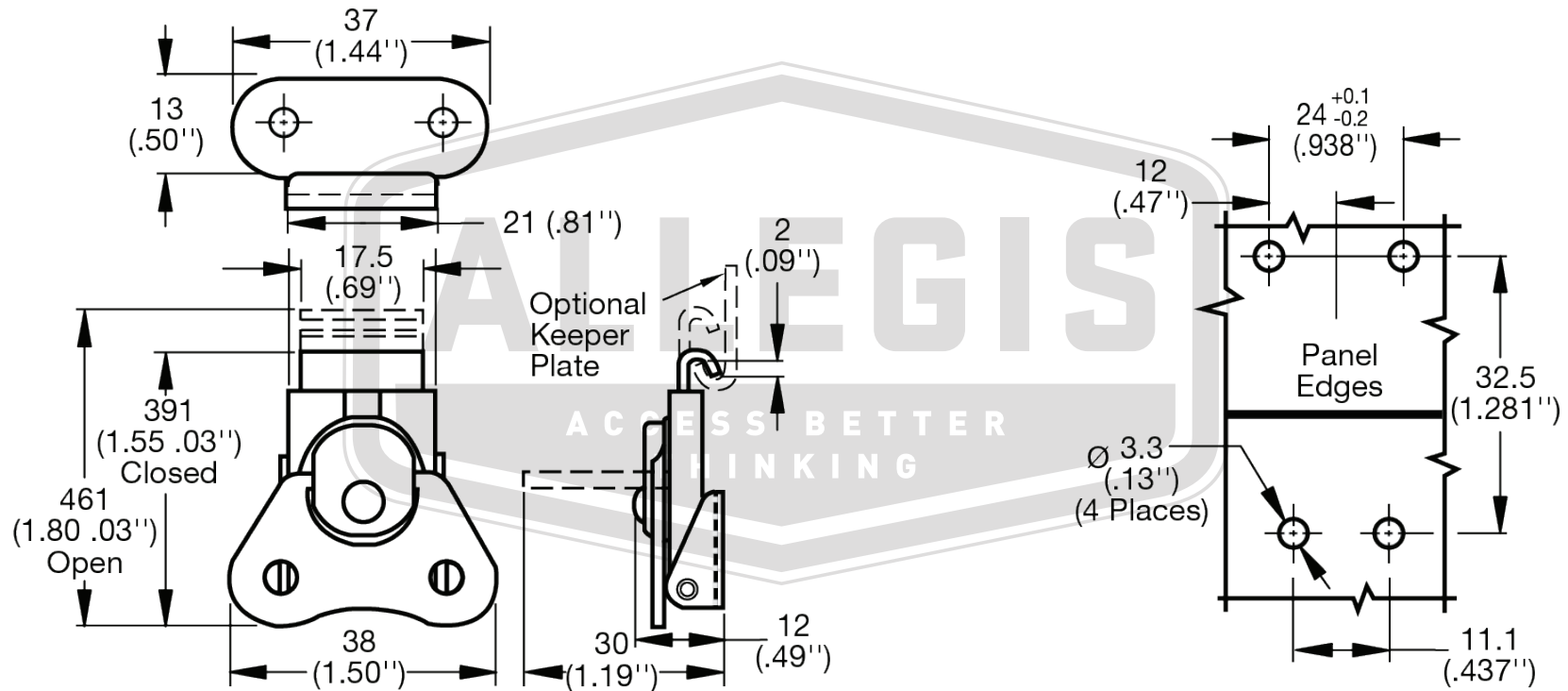

ALLEGIS		1-866-378-7550
MATERIAL:	Stainless Steel	DRAWING NO. : K3-1660-07
FINISH:		
REV.:	1:1	DATE: 6/17/2019